

## Équerre

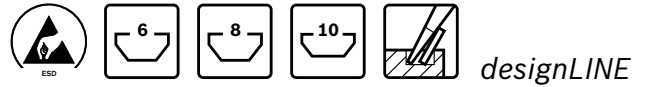





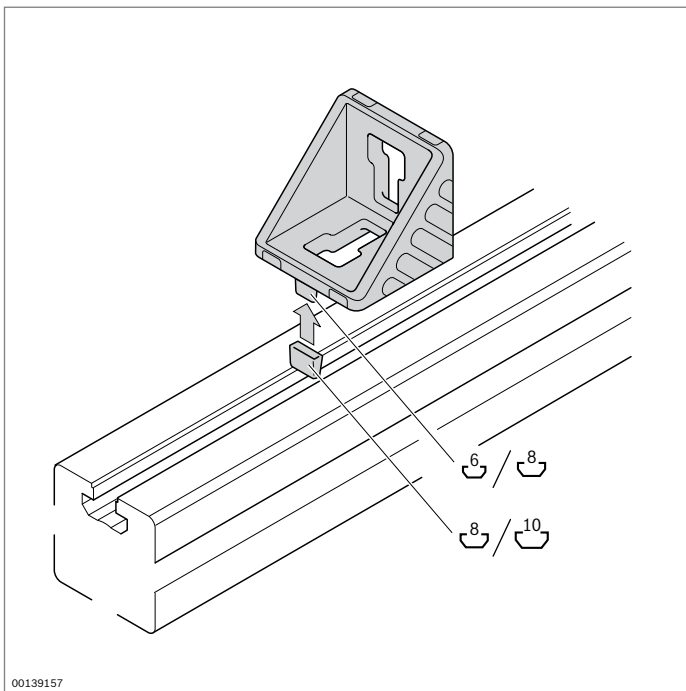

- ▶ Équerre avec ergots de centrage permettant un montage rapide, précis et antitorsion
- ▶ Pour le montage sur plateaux ou en travers de la rainure, il suffit de rompre les ergots de centrage
- ▶ Version *designLINE* avec vernis argenté spécial (RAL 9006) pour un design de grande qualité
- ▶ Pièce intermédiaire pour le positionnement d'équerres dans la rainure directement supérieure
- ▶ Coulisseau retiré pour positionnement décentré de l'équerre 45/45
- ▶ Cache de protection contre l'encrassement, disponible en modèle gris signalisation (RAL 7004) et noir ESD (RAL 9005)
- ▶ Usinage des profilés : inutile

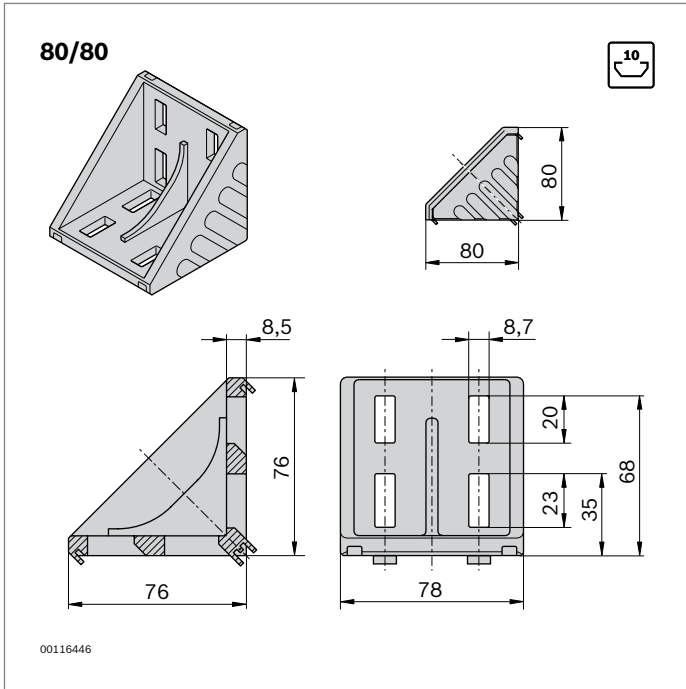
Caractéristiques techniques (p. 19-9)

**Remarque :** Avec les vis d'assemblage, les équerres se montent de manière particulièrement simple et rapide (p. 3-5)









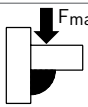
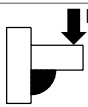
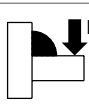
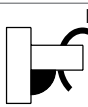

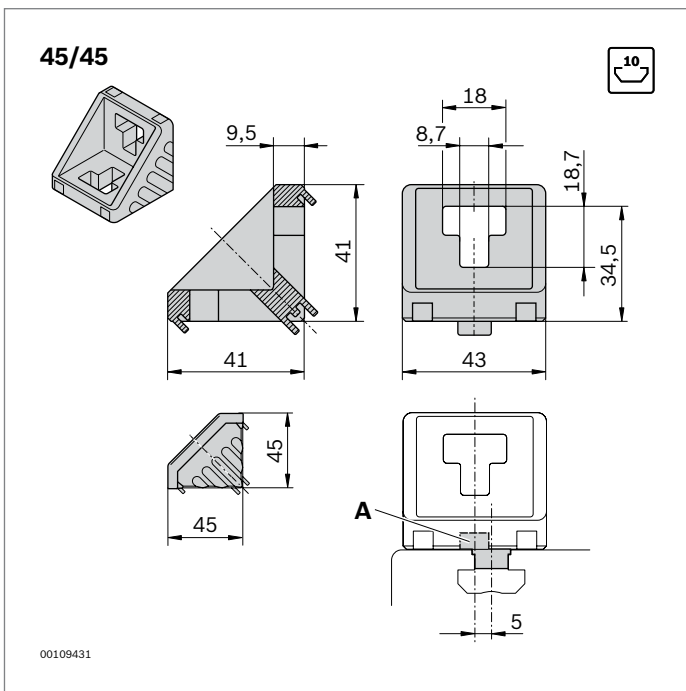
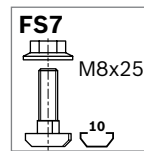
80/80	Rainure	ESD		N°	FS
Jeu (standard)	10 / 10		1	<b>3 842 530 360</b>	8xFS7
Jeu <i>designLINE</i>	10 / 10		1	<b>3 842 551 612</b>	8xFS7
Équerre (standard)	10		20	<b>3 842 530 231</b>	
Cache, gris signalisation			20	<b>3 842 548 860</b>	
Cache, noir			20	<b>3 842 548 861</b>	

Matériaux : Équerre : Aluminium moulé sous pression ; traité par vibro-abrasion  
 Équerre *designLINE* : Vernis (RAL 9006)  
 Cache : PP  
 Matériel de fixation : Acier ; galvanisé  
 Fourniture : Jeu incluant matériel de fixation (FS)

Type				
80/80	14000 N	500 Nm	1000 Nm	400 Nm



45/45	Rainure	ESD		N°	FS
Jeu (standard)	10 / 10		1	<b>3 842 523 561</b>	2xFS7
Jeu <i>designLINE</i>	10 / 10		1	<b>3 842 551 606</b>	2xFS7
Équerre (standard)	10		100	<b>3 842 523 558</b>	
Cache, gris signalisation			100	<b>3 842 548 862</b>	
Cache, noir			20	<b>3 842 548 863</b>	
Coulisseau retiré (A)	10		100	<b>3 842 523 593</b>	

Matériaux : Équerre : Aluminium moulé sous pression ; traité par vibro-abrasion  
 Équerre *designLINE* : Vernis (RAL 9006)  
 Coulisseau retiré : PA ; noir  
 Cache : PP  
 Matériel de fixation : Acier ; galvanisé  
 Fourniture : Jeu incluant matériel de fixation (FS)

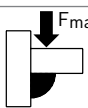
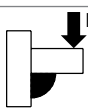
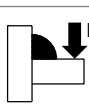
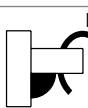
Type				
45/45	3000 N	60 Nm	160 Nm	—

